

---

**harman/kardon®**  
Designed to Entertain.™

# HKS 6

LOUDSPEAKERS  
OWNER'S MANUAL



- 2 Introduction
- 3 Speaker Placement
- 3 Color-Coding System
- 4 Mounting Options
- 5 Speaker Connections
- 5 Connection Guide
- 5 Configuring Your Receiver or Processor
- 6 Troubleshooting
- 7 Specifications

## Introduction

**Thank you** for purchasing the Harman Kardon® HKS 6 loudspeakers, with which you are about to begin many years of listening enjoyment. The HKS 6 has been custom-designed to provide high-fidelity audio reproduction of your favorite music and movie selections. The HKS 6 loudspeakers are suitable for upgrading almost any 5.1 home theater system to 7.1 channels when used with a 7.1-channel receiver or processor and any necessary additional amplifiers.

To obtain maximum enjoyment from your new speakers, we urge you to take a few minutes to read through this manual. This will ensure that connections to your receiver or amplifier are made properly. In addition, a few minutes spent understanding the setup options will enable you to take advantage of all the power and refinement the HKS 6 is able to deliver.

If you have any questions about this product, its installation or operation, please contact your dealer, the best local source of information.

## Features

The HKS 6 is a pair of 2-way satellite speakers for use in a home theater system. The HKS 6 speakers are identical to the satellites in the Harman Kardon HKTS 15 system, and are designed to be used with the HKTS 15 in a complete 7.1-channel home theater. Color-coded speaker cables are included to facilitate installing the speakers in the surround back left and right positions.

Harman Kardon invented the high-fidelity receiver more than 50 years ago. The HKS 6 is a perfect complement to a Harman Kardon receiver or any home theater system.

- **Matched Pair of Loudspeakers for Use in Multichannel Applications**
- **Speakers Are Magnetically Shielded for Flexible Placement Near Video Monitors**
- **Three-Inch Driver**
- **One-Half-Inch Dome Tweeter**
- **Metal-Wire-Mesh Grille**
- **Elegant Cabinet With Black-Lacquer Finish Includes Shelf Stands**
- **Includes Wall-Mount Brackets and Color-Coded Speaker Cables**
- **May Be Used With Optional Floor Stands**

## Included



- Two satellites for left/right front, surround or surround back channels, shown with included shelf stands
- Two leatherette coasters



Two wall-mount brackets



Two 40' speaker cables for connection from receiver or amplifier to speakers

Please register your product on our Web site at [www.harmankardon.com](http://www.harmankardon.com). Note: You'll need the serial number of your new home theater speaker system. At the same time, you can choose to be notified about our new products and/or special promotions.

## Color-Coding System

The HKS 6 and the HKTS 15 use the channel color-coding system established by the Consumer Electronics Association to make setting up your home theater speaker system as easy as possible. Your system includes a set of colored stickers that may be placed near the speaker terminals of each of the satellite speakers. In addition, the included speaker wires have colored bands at each end to assist you in connecting them correctly. Use the brown sticker and cable for the surround back left speaker, and the tan sticker and cable for the surround back right speaker. Although the wires included with your HKS 6 speakers are color-coded for the surround back left and right channels, they are interchangeable with the wires supplied with the HKTS 15 system. It doesn't matter which satellite speaker is used for any of the front or rear positions. (The center speaker and powered subwoofer of the HKTS 15 are already color-coded.)

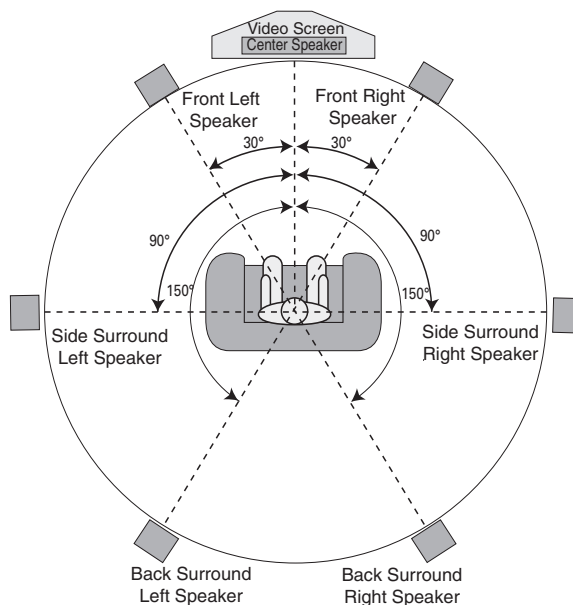

Before you begin to connect cables, it is important to set up your speakers in their correct locations in the room.

Optimally, the speakers should be placed in a circle with the listening position at its center. The distance from the listening position to the video display forms the radius of the circle.

The speakers should be angled so that they directly face the listening position.

The front left and right speakers are placed along the circle, about 30 degrees from the center speaker or video display and angled toward the listener.

When used as a stereo pair, the speakers should be placed the same distance from each other as they are from the listener.

It is best to place the front left/right and center speakers as close to the same height as possible, preferably about the same height as the listener's ears. In any event, the center speaker should be no more than two feet above or below the left/right speakers.

When the HKS 6 speakers are used to upgrade an HKTS 15 system to a 7.1-channel system, the side surround speakers should be placed even with and facing the listening position, 90 degrees from the center speaker. The HKS 6 speakers are then placed in the left and right surround back speaker positions, 150 degrees from the center speaker.

When setting up your system, refer to the diagram above instead of the diagram in the HKTS 15 owner's guide.

The subwoofer's location is less critical, since low-frequency sounds are omnidirectional. Placing the subwoofer close to a wall or in a corner will reinforce the low frequencies, and may create a "boomy" sound. You may wish to experiment over time by placing the subwoofer where the listener normally sits and then walking around the room until the low frequencies sound best. Place the subwoofer in that spot.

# MOUNTING OPTIONS



The satellite speakers may be placed on a shelf. Place each satellite speaker on one of the supplied coasters for added stability and to protect your furniture.



The satellite speakers may also be wall-mounted using the supplied brackets.

## Wall-Mounting

Unscrew the bolt that attaches the black shelf stand to the bottom of the speaker. Store the stand and bolt in a safe place in case they are needed for a future installation.

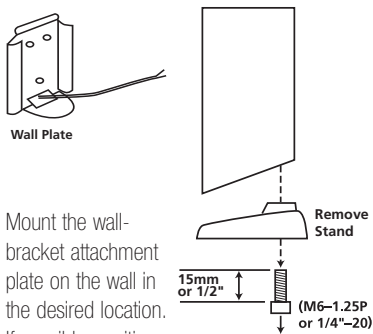

Mount the wall-bracket attachment plate on the wall in the desired location. If possible, position the speakers so that the mounting screws (not included; use size #8) may be installed directly into a wooden wall stud. If that is not possible, use optional wall anchors that are rated to support at least 25 pounds. *The customer is responsible for proper selection and use of mounting hardware, available through hardware stores, to properly and safely wall-mount the speakers.*

Referring to the speaker connection instructions on Page 5, thread the appropriate speaker cable through the opening in the bottom of the wall plate, and then through the back of the bracket as shown in the diagram. The bracket has two openings on top: a round screw hole, and an arc-shaped

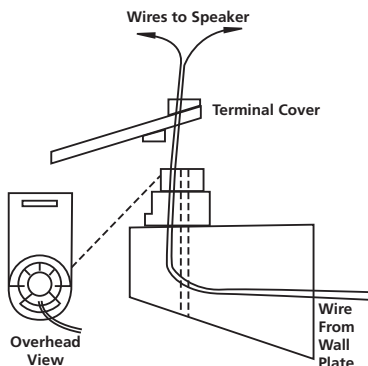

opening in front of it. The speaker cable should be threaded through the arc-shaped opening, not the screw hole.

Attach the bracket to the wall plate by inserting the tab at the top of the wall plate into the slot on top of the bracket and snapping the bracket onto the wall plate.

Thread the cable through the round opening in the terminal cover, and then insert the speaker wires into the terminals on the underside of the speaker, remembering to observe the correct polarity (see Page 5).

Place the terminal cover over the opening on the underside of the speaker so that it fits flush against the speaker and covers the terminals, with its round opening exposing the threaded insert. The bracket fits through the round opening in the terminal cover.

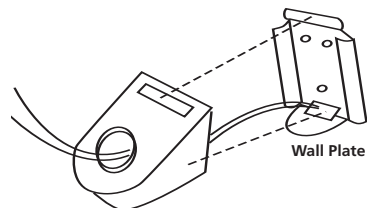

Insert the supplied bracket bolt up through the bottom of the bracket and terminal cover, and screw it into the threaded insert on the underside of the speaker. The bolt should be snug, but not so tight as to prevent the bracket from pivoting.

The wall-mounted speaker may be pivoted from side to side; however, the bracket is *not* designed to tilt up or down, and attempting to tilt it will damage the bracket and possibly the wall, which would not be covered by your warranty.

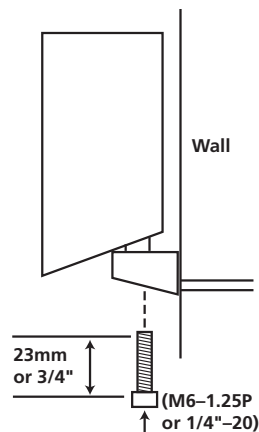

## Connection Guide

**IMPORTANT NOTE:** Before making speaker connections, be certain that your receiver or audio power amplifier is turned off and, preferably, unplugged from its AC power source.

Speakers and electronics terminals have corresponding (+) and (–) terminals. Most manufacturers of speakers and electronics, including Harman Kardon, use red to denote the (+) terminal and black for the (–) terminal.

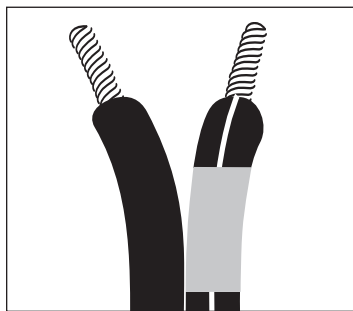

Newer Harman Kardon receivers conform to the new CEA® standard and therefore use a color other than red for the (+) terminal to indicate some speaker positions: e.g., blue for surround left positive (+). However, the black terminal will always be the negative (–) connection. Please see the owner's guide for your Harman Kardon receiver for further details.

Although the HKS 6 speakers may be placed in the front, side surround or surround back positions, the speaker wires provided with the system have been color-coded brown for the surround back left speaker and tan for the surround back right speaker. When used with the HKTS 15 system, it is recommended that you maintain the color-coding system for all cables to simplify setup, and to ensure that each wire in a channel pair (e.g., front left and right) is the same length as its partner.

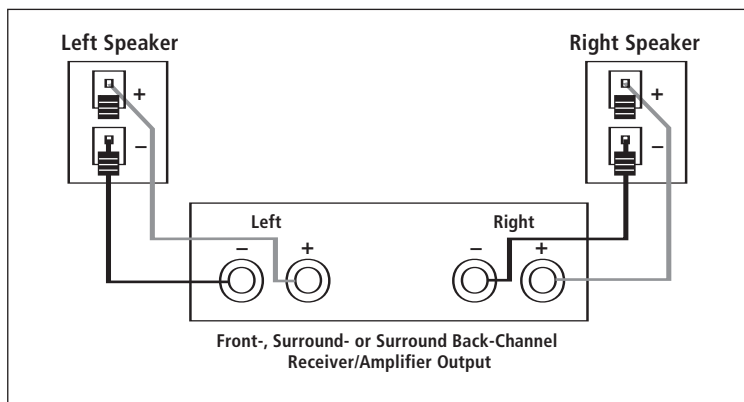

The (+) lead of the speaker wire is noted with a stripe. It is important to connect both speakers identically: (+) on the speaker to (+) on the amplifier and (–) on the speaker to (–) on the amplifier. Wiring “out of phase” results in thin sound, weak bass and a poor stereo image.

With the advent of multichannel surround sound systems, connecting all of the speakers in your system with the correct polarity remains equally important in order to preserve the proper ambience and directionality of the program material.

To connect the supplied speaker wires to the satellite speaker terminals located on the bottom of each speaker, press the red or black tab, insert the bare end of the wire into the hole, and release the tab. Gently tug on the wire to make sure that it is fully inserted.

## Configuring Your Receiver or Processor

Many receivers and processors feature programmable bass-management capability, which allows the component to output the lowest frequencies (the bass information) exclusively to a separate subwoofer speaker, or to a main speaker that is capable of handling low frequencies, or sometimes to both. During the setup process you will be asked to specify whether the speaker for a given channel is “Large” or “Small.” The terms “Large” and “Small” do not refer to physical size, but to the size of the frequency range the speaker is capable of handling. When configuring your receiver or processor for the channels where HKS 6 speakers are being used, select “Small.”

# TROUBLESHOOTING

SYMPTOM	SOLUTION
If there is no sound from any of the speakers:	<ul style="list-style-type: none"><li>• Check that the receiver/amplifier is on and a source is playing.</li><li>• Check all wires and connections between receiver/amplifier and speakers. Make sure all wires are connected. Make sure none of the speaker wires are frayed, cut or punctured, and that no wires are touching each other.</li><li>• Review proper operation of your receiver/amplifier.</li></ul>
If there is no sound coming from one speaker:	<ul style="list-style-type: none"><li>• Check the "Balance" control on your receiver/amplifier.</li><li>• Check all wires and connections between receiver/amplifier and speakers. Make sure all wires are connected. Make sure none of the speaker wires are frayed, cut or punctured, and that no wires are touching each other.</li><li>• In Dolby® Digital or DTS® mode, make sure that the receiver/processor is configured so that the speaker in question is enabled.</li><li>• In Dolby Digital or DTS mode, check the speaker and channel output levels and adjust if needed.</li><li>• Turn off all electronics and switch the speaker in question with one of the other speakers that is working correctly. Turn everything back on, and determine whether the problem is in the same place: i.e., the speaker that was working previously now has no sound and the speaker that was not working now sounds fine; or whether it has moved: i.e., the speaker that was not working still has no sound and the speaker that was working is still fine. If the problem is in the same place, the source of the problem is most likely with your receiver or amplifier, and you should consult the owner's manual for that product for further information. If the problem has followed the speaker, consult your dealer for further assistance or, if that is not possible, visit our Web site at <a href="http://www.harmanardon.com">www.harmanardon.com</a> for further information.</li></ul>
If the system plays at low volumes but shuts off as volume is increased:	<ul style="list-style-type: none"><li>• Check all wires and connections between receiver/amplifier and speakers. Make sure all wires are connected. Make sure none of the speaker wires are frayed, cut or punctured, and that no wires are touching each other.</li><li>• If more than one pair of main speakers is being used, check the minimum impedance requirements of your receiver/amplifier.</li></ul>
If there is low (or no) bass output:	<ul style="list-style-type: none"><li>• Make sure the polarities (+ and -) of the left and right speaker inputs are connected properly.</li><li>• Consider adding a powered subwoofer to your system.</li></ul>
If there is no sound from the surround speakers:	<ul style="list-style-type: none"><li>• Check all wires and connections between receiver/amplifier and speakers. Make sure all wires are connected. Make sure none of the speaker wires are frayed, cut or punctured, and that no wires are touching each other.</li><li>• Review proper operation of your receiver/processor and its surround sound features.</li><li>• Make sure the movie or TV show you are watching is recorded in a surround sound mode. If it is not, check to see whether your receiver/processor has other surround modes you may use.</li><li>• In Dolby Digital or DTS mode, make sure your receiver/processor is configured so that the surround speakers are enabled.</li><li>• Review the operation of your DVD player and the jacket of your DVD to make sure that the DVD features the desired Dolby Digital or DTS mode, and that you have properly selected that mode using both the DVD player's menu and the DVD disc's menu.</li></ul>

**Recommended Power**

10 – 80 Watts

**Impedance**

8 Ohms nominal

**Sensitivity**

86dB @ 1 Watt/1 meter

**Frequency Response**

110Hz – 20kHz (–6dB)

**Tweeter**

One 1/2" dome, video-shielded

**Midrange**

One 3" driver, video-shielded

**Dimensions**

	(Product)	(Shipping)
Height:	6-9/16" (167mm)	6-1/8" (156mm)
Width:	3-15/16" (100mm)	11-5/16" (287mm)
Depth:	3-5/8" (92mm)	10" (253mm)

**Weight**

1.65 lb (0.74kg) 5.1 lb (2.3kg)

**Care and Cleaning**

The loudspeaker enclosures may be cleaned by gently wiping with a soft cotton or microfiber cloth. Do not use water or any liquid cleaners.

Features, specifications and appearance are subject to change without notice.

Harman Kardon is a registered trademark, and Designed to Entertain is a trademark, of Harman International Industries, Incorporated.

CEA is a registered trademark of the Consumer Electronics Association.

Dolby is a registered trademark of Dolby Laboratories.

DTS is a registered trademark of DTS, Inc.

---

**harman/kardon®**

**H A Harman International Company**  
250 Crossways Park Drive, Woodbury, New York 11797  
516.255.HKHK (4545) Fax: 516.682.3523  
© 2006 Harman International Industries, Incorporated.  
All rights reserved.  
Printed 10/06 Part No. 406-000-05547-E